

Article number: 201580M5MTE

Description: E+G Nut GN 1580-M5-MT-E
Hygienic design EPDM

Measures

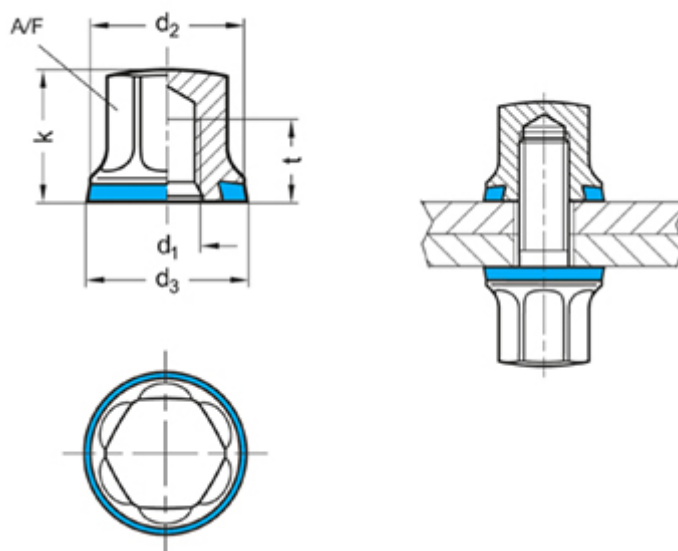

A/F	= 8
d1	= M5
d2	= 12
d3	= 12.8
k	= 10
t min	= 6
Weight in (g)	= 4